

The **Bulldog** Rally

21st OCTOBER 2006

TRADE PACK

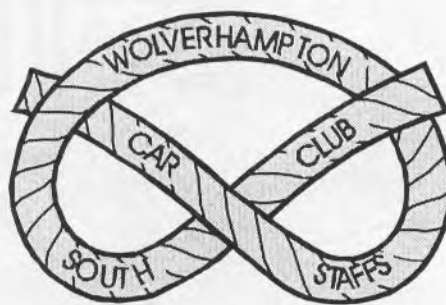

CONTENTS

	PAGE
□ OSWESTRY MAP	1
□ DIAGRAM of BULLDOG RALLY BASE	2
□ MANAGEMENT CAR ROUTE by TULIP DIAGRAM	3
□ MAP OF RALLY CAR / MANAGEMENT / SERVICE	27
□ TIME SCHEDULE	28
□ SERVICE DETAILS	29
□ STAGE MAPS	31
□ ENTRY LIST	

VEHICLE PASSES and all **REMAINING DETAILS** can be collected from **COMPETITOR RECEPTION** in the **PEDIGREE, BULLDOG RALLY BASE**, from 2.00pm on **FRIDAY 20th OCTOBER**

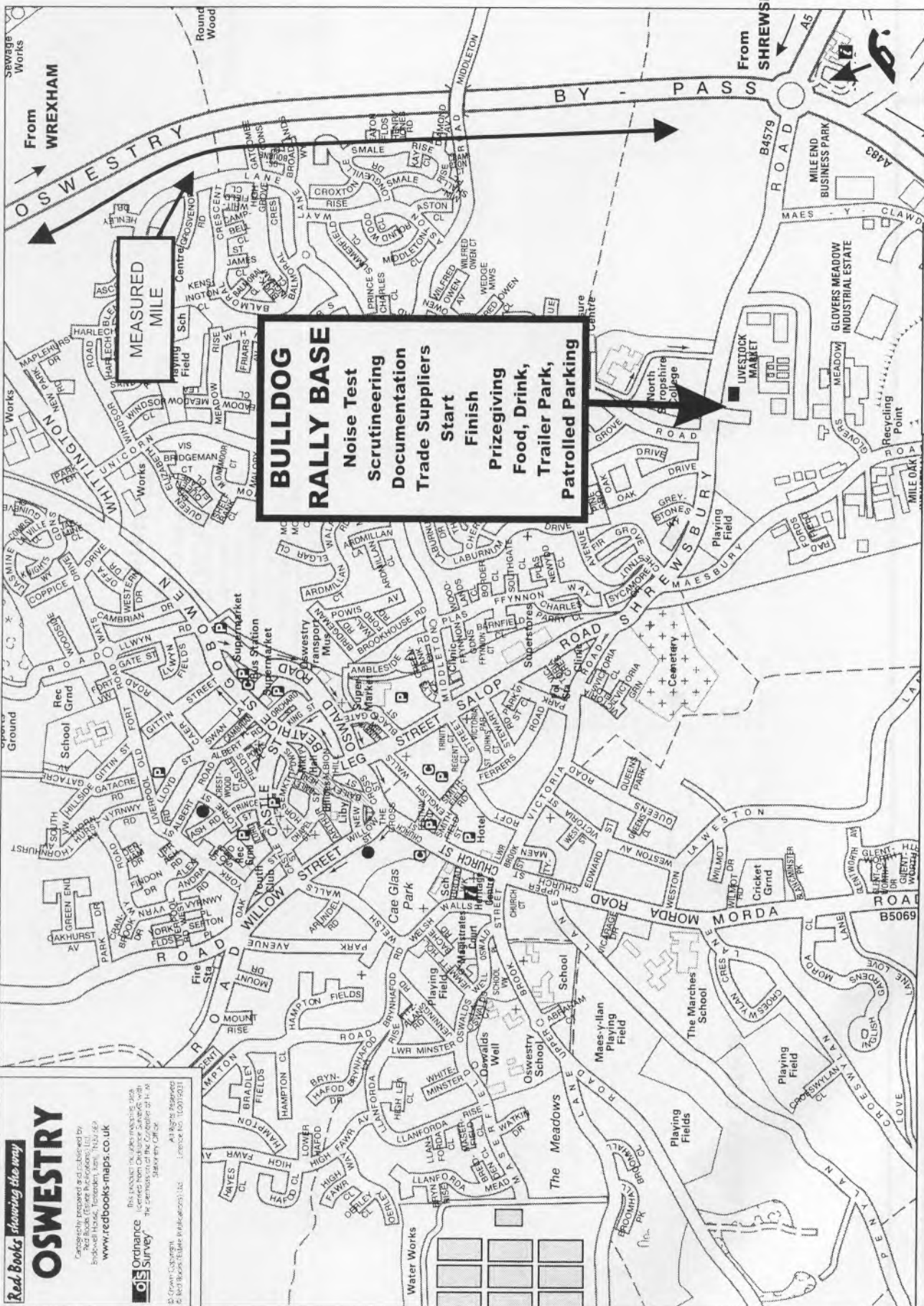

BULLDOG RALLY BASE
 Noise Test
 Scrutineering
 Documentation
 Trade Suppliers
 Start
 Finish
 Prizegiving
 Food, Drink,
 Trailer Park,
 Patrolled Parking

MEASURED MILE

To
 STAGE 1 &
 SERVICE

NOT TO
 SCALE

BULLDOG RALLY 2006

Red Books showing the way

OSWESTRY

Copyright reserved and published by
 Ordnance Survey
 100 Brook Hill Drive, Exton, Leicestershire, LE19 76Q

www.redbooks-maps.co.uk

This document includes Ordnance Survey
 data licensed from Ordnance Survey with
 the permission of the Controller of H. M.
 Stationery Office.

© Crown Copyright
 © North Books (Publishers) Ltd. Licence No. 100715021

From Town Centre



SHREWSBURY ROAD B4579

From Shrewsbury
Wrexham & A5

ASSEMBLY
AREA

THE PEDIGREE
RECEPTION
HELP DESK
DOCUMENTATION
TOILETS
FOOD / DRINK

TRADE
FUEL AREA

LADIES
TOILET

GENTS
TOILET

TRADE PARKING

SCRUTINEERING

TRAILER PARK

NOISE TEST







Pre Noise Check Waiting Area

NO ACCESS

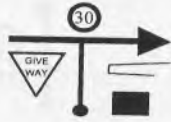





NO ACCESS

OSWESTRY RALLY BASE - BULLDOG RALLY 2006







**NOT TO
SCALE**

MILES		DIRECTION	INFORMATION	MILES to TC
TOTAL	INTERVAL			
0.00	0.00	 0	Zero trip as joining Main Road.	62.06
0.51	0.51	 1	WELSHPOOL A483	61.55
1.57	1.06	 2		60.49
3.96	2.39	 3	LLANSANTFFRAID A495 MACHYNLETH (A458)	58.10
4.19	0.23	 4		57.87
6.06	1.87	 5	Llansantffraid A495 Llanfyllin (B4393) Machynlleth (A458)	56.00







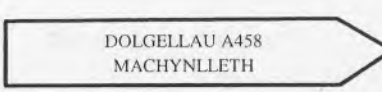

Bulldog Rally 2006

MILES		DIRECTION	INFORMATION	MILES to TC
TOTAL	INTERVAL			
8.44	2.38	 6	Llansantffraid-Ym-Mechain	53.62
8.76	0.32	 7		53.30
9.19	0.43	 8	Llanfyllin Lake Vyrnwy B4393	52.87
10.86	1.67	 9	LLANFECHAIN	51.20
12.84	1.98	 10	LLANFYLLIN A490	49.22
13.76	0.92	 11		48.30





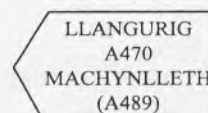
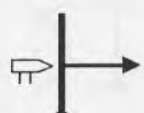



BULLDOG RALLY BASE, OSWESTRY
TO
DOLGELLAU, SERVICE A

MILES		DIRECTION	INFORMATION	MILES to TC
TOTAL	INTERVAL			
14.57	0.81	 12	LLANFYLLIN	47.49
15.59	1.02	 13	LLANWDDYN B4393	46.47
20.01	4.42	 14	LLANWDDYN B4393	42.05
22.87	2.86	 15	COWNWY	39.19
23.79	0.92	 16	DO NOT FOLLOW RALLY CAR LLANGADFAN	38.27
25.88	2.09	 17		36.18

Bulldog Rally 2006

MILES		DIRECTION	INFORMATION	MILES to TC
TOTAL	INTERVAL			
BULLDOG RALLY BASE, OSWESTRY		PAGE		6
TO		DISTANCE		62.06 MILES
DOLGELLAU, SERVICE A				
29.13	3.25			32.93
		18		
30.19	1.06			31.87
		19		
30.63	0.44		START OF EMERGENCY SERVICE NOT SERVICE ON CARRIAGEWAY 	31.43
		20		
39.61	8.98			22.45
		21		
41.81	2.20			20.25
		22	End of emergency service	
42.05	0.24		Ignore 'No Entry'.	20.01
		23		

Bulldog Rally 2006

MILES		DIRECTION	INFORMATION	MILES to TC
TOTAL	INTERVAL			
42.60	0.55	 24	Past spectator entrance.	19.46
43.11	0.51	 25	Ignor 'No Entry' sign. CARE CROSSING RALLY TRAFFIC	18.95
43.56	0.45	 26	DO NOT FOLLOW RALLY CAR	18.50
45.56	2.00	 27	Start of Emergency Service 	16.50
46.01	0.45	 28	Onto asphalt. End of Emergency Service 	16.05
46.22	0.21	 29		15.84

BULLDOG RALLY BASE, OSWESTRY

PAGE

7





TO

DISTANCE



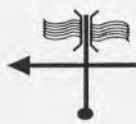

62.06 MILES

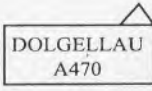
DOLGELLAU, SERVICE A

Bulldog Rally 2006

MILES		DIRECTION	INFORMATION	MILES to TC
TOTAL	INTERVAL			
BULLDOG RALLY BASE, OSWESTRY		PAGE		8
TO		DISTANCE		62.06 MILES
DOLGELLAU, SERVICE A				
47.53	1.31	 30	Care - Rally traffic crossing your path.	14.53
48.16	0.63	 31	Slow and Quiet through village. Children playing.	13.90
48.58	0.42	 32	PC2	13.48
48.76	0.18	 33	↕	13.30
48.99	0.23	 34	↕ Emergency Service permitted	13.07
51.19	2.20	 35	↕ 	10.87

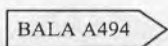
Bulldog Rally 2006

MILES		DIRECTION	INFORMATION	MILES to TC
TOTAL	INTERVAL			
52.02	0.83	 36		10.04
61.96	9.94	 37	No Emergency Service 	0.10
62.06	0.10	 38	 Enter Service Area	0.00

BULLDOG RALLY BASE, OSWESTRY

PAGE

9

TO

DISTANCE

62.06 MILES

DOLGELLAU, SERVICE A

Bulldog Rally 2006

Service area A - Dolgellau

A470
To Ffestiniog



RESULTS



From Stage 2









REFUEL

To Stage 3













REFUEL



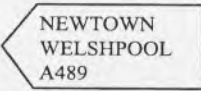

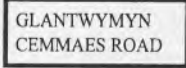

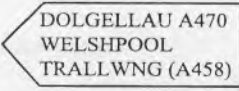
A494 To
Bala

MILES		DIRECTION	INFORMATION	MILES to TC
TOTAL	INTERVAL			
DOLGELLAU, SERVICE A		PAGE		11
TO		DISTANCE		44.35
DOLGELLAU, SERVICE B				
0.00	0.00	 0	LEAVE SERVICE (DO NOT PASS THROUGH THE CONTROL AREA)	44.35
0.05	0.05	 1	MACYNLLETH (A487) LLANGURIG A470	44.30
0.70	0.65	 2		43.65
2.93	2.23	 3	MACHYNLLETH A487	41.42
8.68	5.75	 4	Slow and quiet through CORRIS UCHAF	35.67
13.13	4.45	 5	 EMERGENCY SERVICE IN PICNIC AREA ONLY	31.22



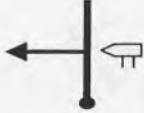





Bulldog Rally 2006

		DOLGELLAU, SERVICE A		PAGE	12
		TO		DISTANCE	44.35
		DOLGELLAU, SERVICE B			
MILES		DIRECTION	INFORMATION	MILES to TC	
TOTAL	INTERVAL				
13.13	0.00	 6	 EMERGENCY SERVICE IN PICNIC AREA ONLY 		31.22
15.49	2.36	 7	 Emergency Service Permitted		28.86
17.81	2.32	 8			26.54
20.11	2.30	 9	NO Emergency Service Permitted 		24.24
20.21	0.10	 10			24.14
20.42	0.21	 11	 Emergency Service Permitted		23.93





Bulldog Rally 2006

MILES		DIRECTION	INFORMATION	MILES to TC
TOTAL	INTERVAL			
DOLGELLAU, SERVICE A		PAGE		13
TO		DISTANCE		44.35
DOLGELLAU, SERVICE B				
21.86	1.44			22.49
		12		
22.99	1.13		CWM LLINAU	21.36
		13		
24.33	1.34		ABERANGELL 1/4	20.02
		14		
24.56	0.23			19.79
		15		
25.12	0.56		Past spectator entrance.	19.23
		16		
25.63	0.51		Ignor 'No Entry' sign.	18.72
		17		
		CARE CROSSING RALLY TRAFFIC		

Bulldog Rally 2006

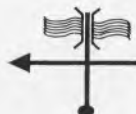
		DOLGELLAU, SERVICE A		PAGE	14
		TO		DISTANCE	44.35
		DOLGELLAU, SERVICE B			
MILES		DIRECTION	INFORMATION	MILES to TC	
TOTAL	INTERVAL				
26.09	0.46	 18			18.26
27.85	1.76	 19	 START OF EMERGENCY SERVICE		16.50
28.30	0.45	 20	Onto asphalt.  END OF EMERGENCY SERVICE		16.05
28.51	0.21	 21			15.84
29.82	1.31	 22			14.53
30.45	0.63	 23	Slow and Quiet through village. Children playing.		13.90

Bulldog Rally 2006

MILES		DIRECTION	INFORMATION	MILES to TC
TOTAL	INTERVAL			
BULLDOG RALLY BASE, OSWESTRY		PAGE		15
TO		DISTANCE		44.35
DOLGELLAU, SERVICE A				
30.87	0.42	 24		13.48
31.05	0.18	 25	↕	13.30
31.28	0.23	 26	↕	13.07
33.48	2.20	 27	↕ DOLGELLAU A470	10.87
34.31	0.83	 28		10.04
44.25	9.94	 29	BALA A494	0.10

Bulldog Rally 2006

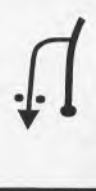
MILES		DIRECTION	INFORMATION	MILES to TC
TOTAL	INTERVAL			
44.35	0.10		↑↓ TC2 ENTER SERVICE AREA	0.00

BULLDOG RALLY BASE, OSWESTRY

PAGE 16

TO

DISTANCE 44.35

DOLGELLAU, SERVICE A

Service area B - Dolgellau

A470
To Ffestiniog



RESULTS







From Stage 4

REFUEL







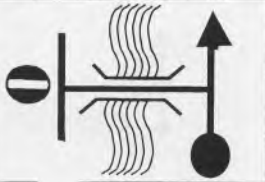



To Stage 5

REFUEL

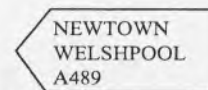

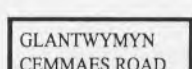

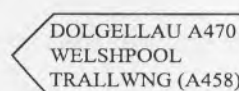

A494 To
Bala

MILES		DIRECTION	INFORMATION	MILES to TC
TOTAL	INTERVAL			
DOLGELLAU, SERVICE B		TO		PAGE 18
		FINISH		DISTANCE 71.69 MILES
0.00	0.00		LEAVE SERVICE (DO NOT PASS THROUGH THE CONTROL AREA)	71.69
		0		
0.09	0.09		MACYNLLETH (A487) LLANGURIG A470	71.60
		1		
0.74	0.65			70.95
		2		
3.06	2.32		MACHYNLLETH A487	68.63
		3		
8.81	5.75		Slow and quiet through CORRIS UCHAF	62.88
		4		
11.55	2.74			60.14
		5	DO NOT FOLLOW RALLY CARS	

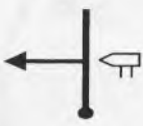
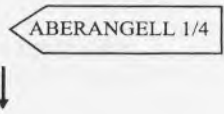
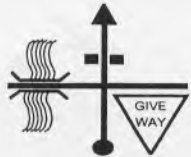

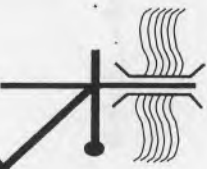







Bulldog Rally 2006

		DOLGELLAU, SERVICE B		PAGE	19
		TO		DISTANCE	71.69 MILES
		FINISH			
MILES		DIRECTION	INFORMATION	MILES	
TOTAL	INTERVAL			to TC	
15.62	4.07				56.07
		6			
17.94	2.32				53.75
		7			
20.32	2.38				51.37
		8			
20.42	0.10				51.27
		9			
20.69	0.27				51.00
		10			
22.13	1.44				49.56
		11			







Bulldog Rally 2006

MILES		DIRECTION	INFORMATION	MILES to TC
TOTAL	INTERVAL			
23.26	1.13	 12	CWM LLINAU	48.43
24.60	1.34	 13		47.09
24.83	0.23	 14		46.86
25.39	0.56	 15	Past spectator entrance.	46.30
25.90	0.51	 16	 Great care crossing rally traffic !	45.79
26.50	0.60	 17	 CARE TWO WAY RALLY TRAFFIC	45.19



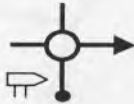
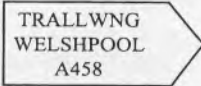

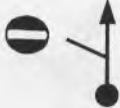
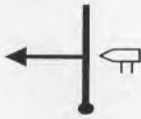

Bulldog Rally 2006

		DOLGELLAU, SERVICE B		PAGE	21
		TO		DISTANCE	71.69 MILES
		FINISH			
MILES		DIRECTION	INFORMATION	MILES	
TOTAL	INTERVAL			to TC	
27.06	0.56	 18	 CARE RALLY CARS FROM LEFT Emergency service on forest road to right		44.63
27.06	0.00	 19	 CARE RALLY CARS		44.63
27.62	0.56	 20			44.07
28.22	0.60	 21	 Onto Asphalt.		43.47
28.85	0.63	 22	Slow and Quiet through village. Children playing. 		42.84
29.28	0.43	 23			42.41

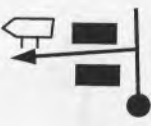
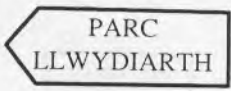



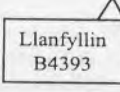

Bulldog Rally 2006

MILES		DIRECTION	INFORMATION	MILES to TC
TOTAL	INTERVAL			
DOLGELLAU, SERVICE B		TO FINISH		PAGE 22
				DISTANCE 71.69 MILES
29.46	0.18			42.23
		24		
29.69	0.23			42.00
		25	Emergency service permitted	
31.89	2.20			39.80
		26		
41.20	9.31		End of Emergency Service 	30.49
		27		
41.34	0.14			30.35
		28		
42.59	1.25			29.10
		29		







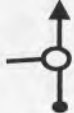

Bulldog Rally 2006

		DOLGELLAU, SERVICE B		PAGE	23
		TO FINISH		DISTANCE	71.69 MILES
MILES		DIRECTION	INFORMATION	MILES	
TOTAL	INTERVAL			to TC	
44.29	1.70		CARE! - Spectator entrance		27.40
		30			
45.84	1.55				25.85
		31			
46.44	0.60		CARE SPECTATORS		25.25
		32			
47.93	1.49		CARE RALLY CARS FROM THE LEFT		23.76
		33			
48.85	0.92		 START OF EMERGENCY SERVICE ALL SERVICE MUST BE OFF THE CARRIAGEWAY		22.84
		34			
51.72	2.87				19.97
		35			

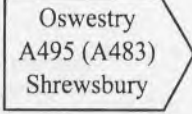

Bulldog Rally 2006

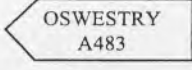
DOLGELLAU, SERVICE B		PAGE	24	
TO		DISTANCE	71.69 MILES	
FINISH				
MILES		DIRECTION	INFORMATION	MILES to TC
TOTAL	INTERVAL			
56.14	4.42	 36	Llanfyllin A490	15.55
56.41	0.27	 37	LLANFYLLIN	15.28
58.90	2.49	 38	Llansantffraid -ym-Mechain B4393	12.79
60.33	1.43	 39	LLANFECHAIN	11.36
62.37	2.04	 40	LLANSANTFFRAID -YM-MECHAIN	9.32
62.55	0.18	 41	Meifod Dolgellau Machynlleth	9.14

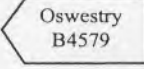
Bulldog Rally 2006

MILES		DIRECTION	INFORMATION	MILES to TC
TOTAL	INTERVAL			
62.96	0.41	 42		8.73
65.68	2.72	 43		6.01
67.39	1.71	 44		4.30
67.79	0.40	 45		3.90
70.18	2.39	 46		1.51
71.17	0.99	 47	 No Emergency Service Permitted	0.52

Bulldog Rally 2006

MILES		DIRECTION	INFORMATION	MILES to TC
TOTAL	INTERVAL			
71.46	0.29	 48	OSWESTRY	0.23
71.69	0.23	 49	Follow marshals directions to control.	0.00

DOLGELLAU, SERVICE B

PAGE

26

TO
FINISH

DISTANCE

71.69 MILES

Bulldog Rally 2006

START & FINISH
 BULLDOG RALLY BASE
 OSWESTRY

NO
 emergency service
 before Stage 1

SERVICE & TRADE
 VEHICLE ROUTE
 TO AND FROM
 SERVICE

Start of
 emergency service
 after Stage 6
OFF carriageway

Start Stage 1
 Finish Stage 6

Finish Stage 1
 Start Stage 6

Start of
 emergency service
 after Stage 1
OFF carriageway

Emergency service
 stage 2 & 4
 on forest road

Emergency service
 for stage 5
 on forest road

SERVICE A & B
 Dolgellau Mart

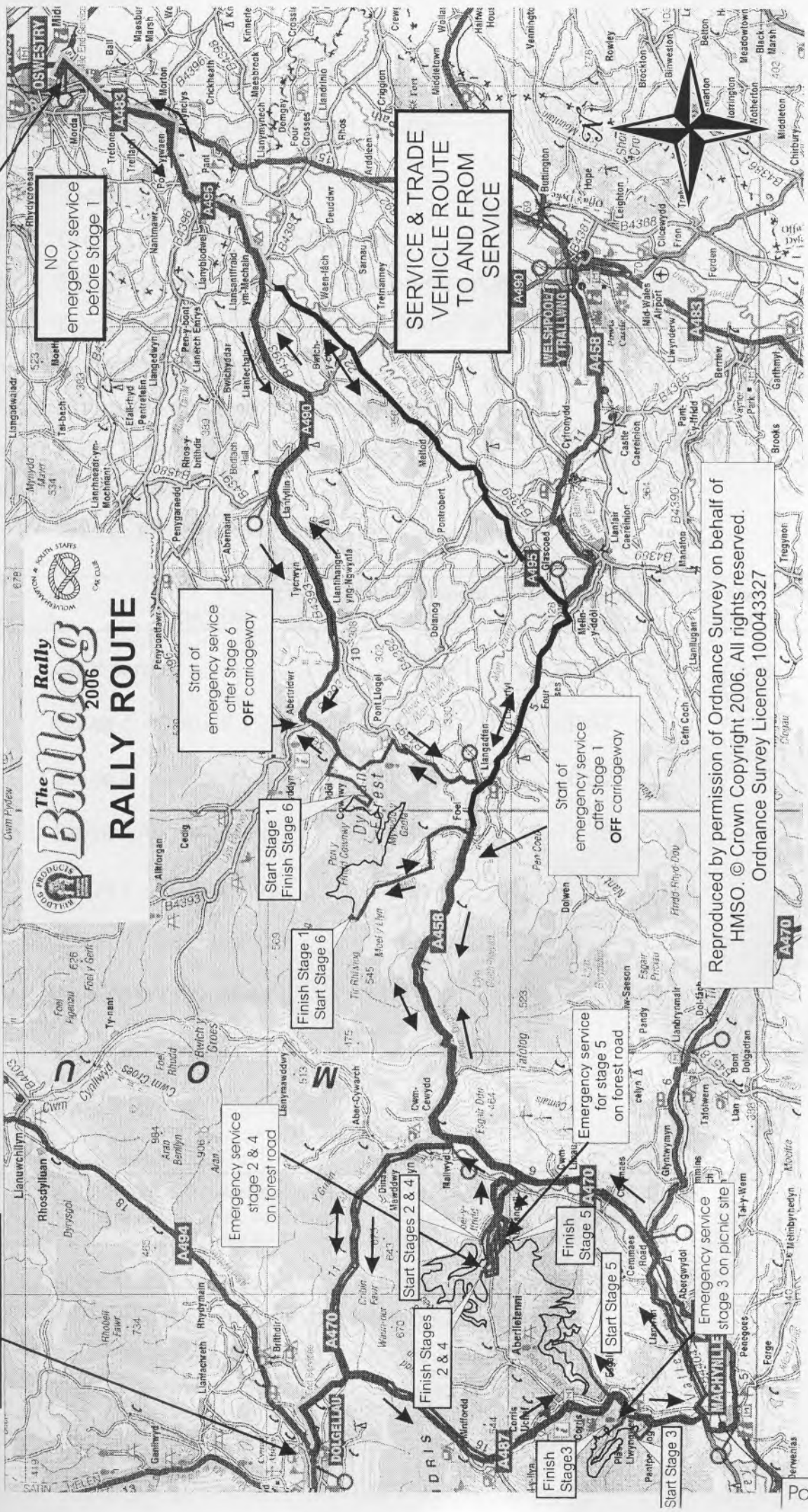

The Bulldog
 2006
RALLY ROUTE

Reproduced by permission of Ordnance Survey on behalf of
 HMSO. © Crown Copyright 2006. All rights reserved.
 Ordnance Survey Licence 100043327

BULLDOG RALLY 2006

The programme of the meeting will be:

Friday 20th October

- 10:00 hrs Press Office & Help Desk open
- 14.00 hrs Scrutineering & Noise Check opens at Bulldog Rally Base
- 14.00 hrs Documentation opens at The Pedigree Bulldog Rally Base
- 19.30 hrs Noise Check closes
- 20.00 hrs Scrutineering and Documentation close
- 21.00 hrs Rally Press Office & Help Desk close

Saturday 21st October

- 07.00 hrs Press Office & Rally Help Desk open

CONTROL	LOCATION	First National Car Due	First Clubmans Car Due	First Mini Rally Car Due
MC0	Start control	08:00	09:00	10:25
ATC1	Stage 1 - Dyfnant 1	08:54	09:54	11:19
ATC2	Stage 2 - Gartheiniog 1	09:50	10:50	
TC2	Service A - Dolgellau	10:46	11:46	
ATC3	Stage 3 - Pantperthog	12:07		
ATC4	Stage 4 - Gartheiniog 2	12:42		
TC4	Service B - Dolgellau	13:38		
ATC5	Stage 5 - Dyfi Main	14:45	12:53	
ATC6	Stage 6 Dyfnant	15:47	13:55	12:10
MC6	Finish control	16:59	15:07	13:22

NOTE - (1)The scheduled times of the first car in Clubmans and Mini Rallies **WILL** vary depending upon the final number of entries. (2) The prizegiving for The Bulldog Rally is on the finish ramp.

- 17:00 Provisional results for the Bulldog Clubmans Rally posted
- 18:00 Provisional results for the Bulldog Rally posted
- 18:00 Prizegiving for Bulldog Clubmans Rally in Pedigree

NOTES FOR SERVICE CREWS

Read these instructions carefully, and exercise care and courtesy when driving through towns and villages on route.

Each registered Service Vehicle is issued with a Rally Service Plate which must be affixed to the vehicle's windscreen. This plate will bear the letter 'S' and a number corresponding to that of the competitor receiving the Service Pack where practical.

Each Management vehicle will have similar plate but bearing the prefix 'M', to be fixed to the vehicle and be on display at all times.

Service Crews and Management Crews **MUST** follow the instructions given regarding Service Areas and the route between them. Any Competitor whose Service or Management Vehicle is *observed* in an OUT OF BOUNDS area will be penalised 10 minutes for the first offence and by EXCLUSION from the results for the second offence; any Competitor *receiving assistance* from a Service or Management Vehicle in an OUT OF BOUNDS area will be EXCLUDED on the **first offence** (see Art.17.8).

All the above vehicles will be allowed into the main Service Area.

Time Controls are situated at the exit of each main service area and service crews must follow the instructions of marshals at these controls.

Regrouping will operate in service areas A and B, to close up any gaps and keep the rally together as much as possible.

Judges of Fact will be patrolling the road sections and service crews are reminded that their associated competing car may be penalised for any infringement of the servicing regulations - including excessive noise, bad driving manners, etc. (see Art. 17.6).

In the event of their competitor retiring within a special stage, service crews may wait at the start of the stage until it closes and they will then be allowed to enter to retrieve the car under the instruction of the stage commander.

As usual the various Police Authorities will be observing the Rally and speed checks may be expected during the event.

SERVICING & SERVICE AREA

Competitors are reminded that they are responsible for the conduct of their service crews.

ONLY vehicles registered with the organisers and visibly displaying their Service Plate will be allowed to enter the service area.

NO RALLY PLATE - NO ENTRY

SERVICE LOCATION

FIRST CAR DUE TIME ALLOWED

A DOLGELLAU 10.46 hrs. Minimum service time 20 minutes
Entry - 124/735181¹/₂

Servicing in Farmers Mart complex.

Hot food and drinks will be available as well as male & female toilets.

B DOLGELLAU 13.28 hrs. Minimum service time 20 minutes
Entry - 124/735181¹/₂

The designated SERVICE ROUTE

Start at Oswestry to Dolgellau

Turn right out of Bulldog Rally Base, onto B4579 towards A5

A483 from Mile End roundabout to Llyncllys

A495 from Llyncllys to Melin-y-ddôl

A458 Melin-y-ddôl to Mallwyd

A470 Mallwyd to Dolgellau

A494 to Farmers Mart from A470

Dolgellau to Finish at Oswestry.

A494 from Farmers Mart to A470

A470 from junction A494 to Mallwyd

A458 from Mallwyd to Melin-y-ddôl

A495 from Melin-y-ddôl to Llyncllys

A483 from Llyncllys to Mile End roundabout

B4579 to Bulldog Rally Base.

SUMMARY OF COMPETITOR'S RALLY MILEAGES

<u>Rally Section</u>	<u>Road Miles</u>	<u>Stage Miles</u>	<u>No. Of Stages</u>
Start to Service A	62	26	2
Service A to Service B	35	26	2
Service B to Finish	60	18	3

MANAGEMENT SERVICE

Regulation Article 17.2. Each Service or Management Vehicle must be registered with the Organisers, giving its vehicle registration number, before an official plate is issued for it. The use of a Service or Management plate on a vehicle not previously registered with the Organisers is an offence for which a penalty up to **EXCLUSION** may be applied.

Article 17.4 Emergency servicing will be permitted in designated areas after some Special Stages, from Management Vehicles displaying the appropriate Management Plate. These plates may only be used on conventional saloon cars or their estate car derivatives, or on certain 4x4 off-road leisure vehicles, subject to approval by the Organisers. The use of roof racks is not permitted. These vehicles must follow the instructions issued by the Organisers in the Service Pack, which will specify sections of the rally route which are Out of Bounds to Management Vehicles. Application for a Management Plate must be made on the Official Entry Form (see Article 8.8). The Organisers reserve the right to restrict or refuse any application for additional plates.

AREAS OF 'NO EMERGENCY SERVICE' ARE DESIGNATED IN THE ROAD BOOK BY A THICK LINE ON THE RIGHT HAND SIDE OF THE 'INFORMATION' COLUMN

Where emergency service is permitted on the public highway competitors must be completely off the carriageway when stopped and not in a area restricted to 40 mph or less.

LOCATIONS WHERE EMERGENCY SERVICE IS PERMITTED

Between start & Stage 1 - NO EMERGENCY SERVICE PERMITTED

Between stage 1 & 2 – Road Book(RB) ref 5 to RB 8 (OFF carriageway along A458 and A470)

Between stage 2 & service A – RB 0 to RB 1 (Forest road after stage 2)

and – RB 7 to RB 10 (OFF carriageway along A470)

Between service A & stage 3 – NO EMERGENCY SERVICE PERMITTED

Between stage 3 & stage 4 – RB 1 (Only in Picnic Area off A487)

and – RB 2 to RB 4 (OFF carriageway along B4404)

and – RB6 to RB 10 (OFF carriageway along A470)

Between stage 4 & service B – RB 0 to RB1 (on forest road)

and – RB 7 to RB 10 (OFF carriageway along A470)

Between service B & stage 5 – NO EMERGENCY SERVICE PERMITTED

Between stages 5 & stage 6 – RB 1 (On forest road at hairpin bend)

and – RB 7 to RB 9 (OFF carriageway along A458 and A470)

Between stage 6 & Finish – RB 5 to RB 18 (OFF carriageway along B4393, A490,A495 and A483)

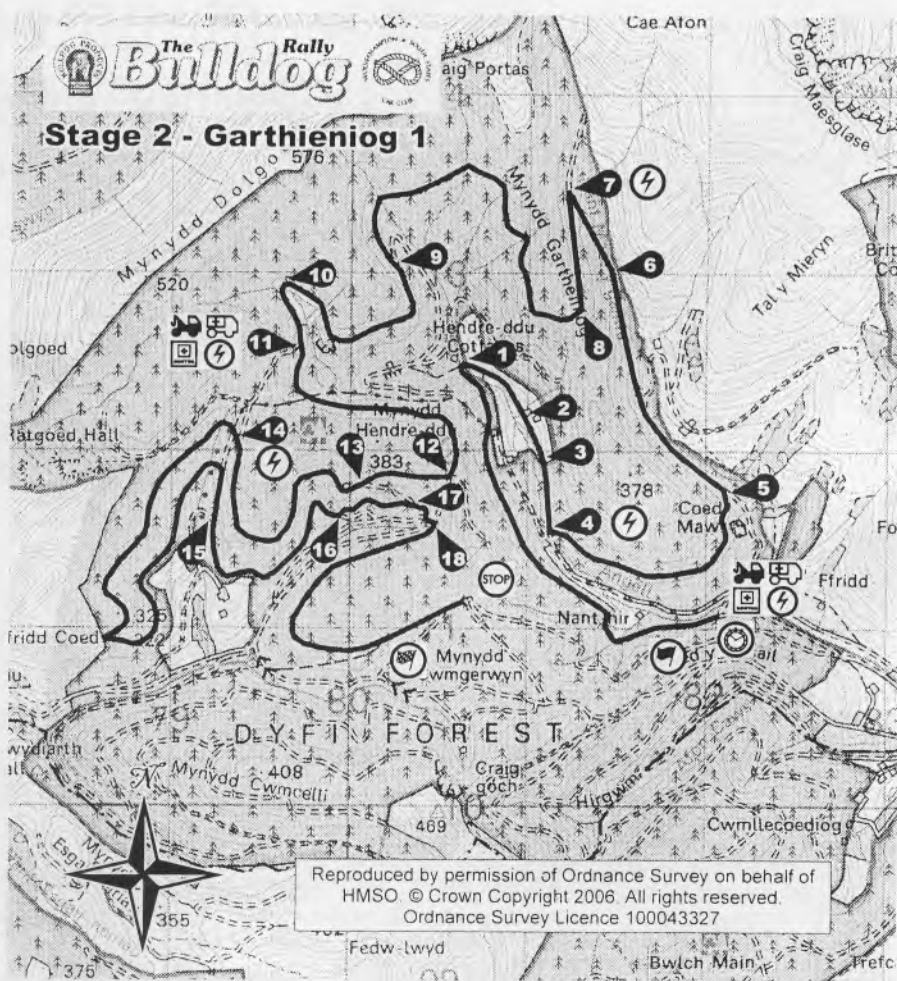
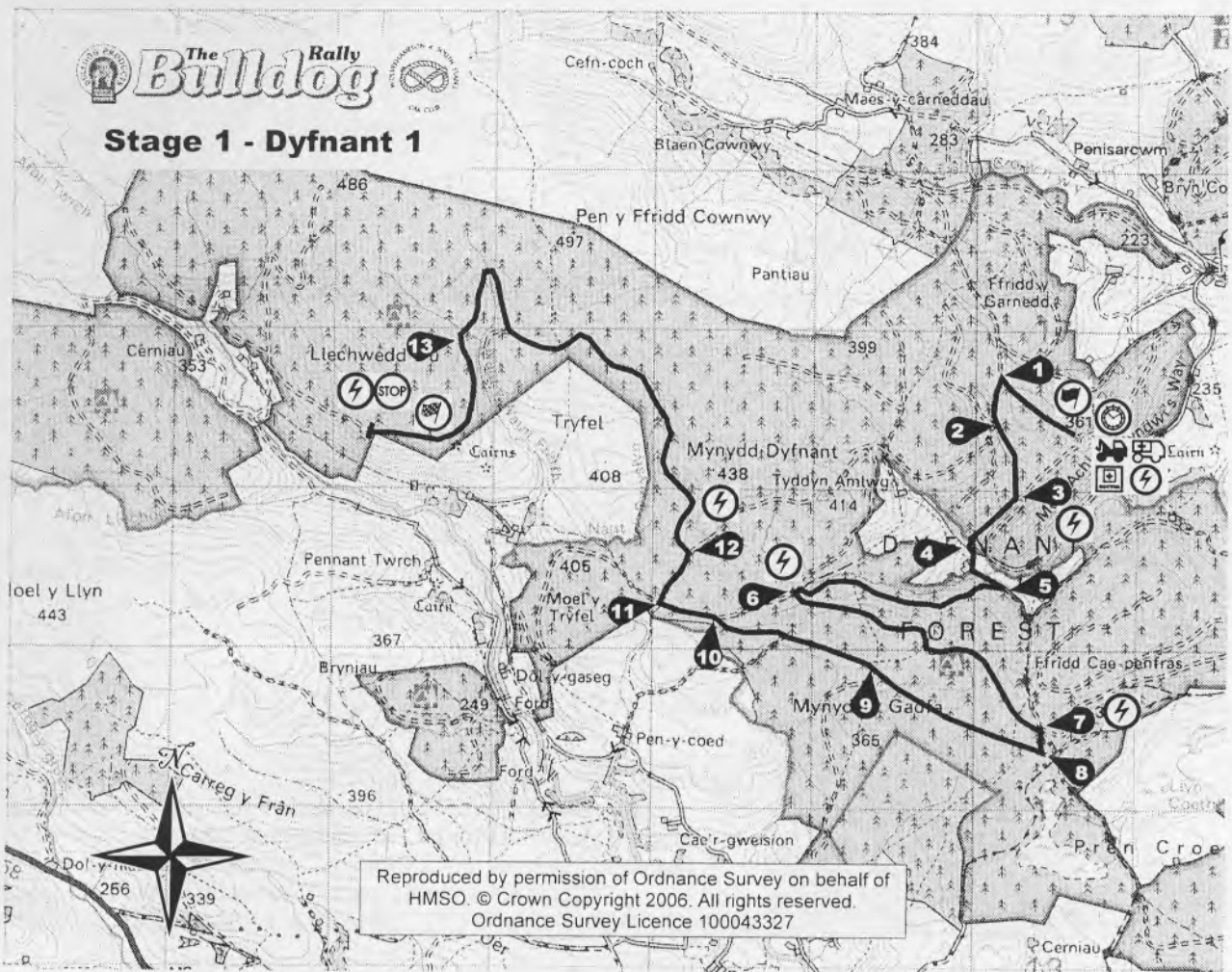

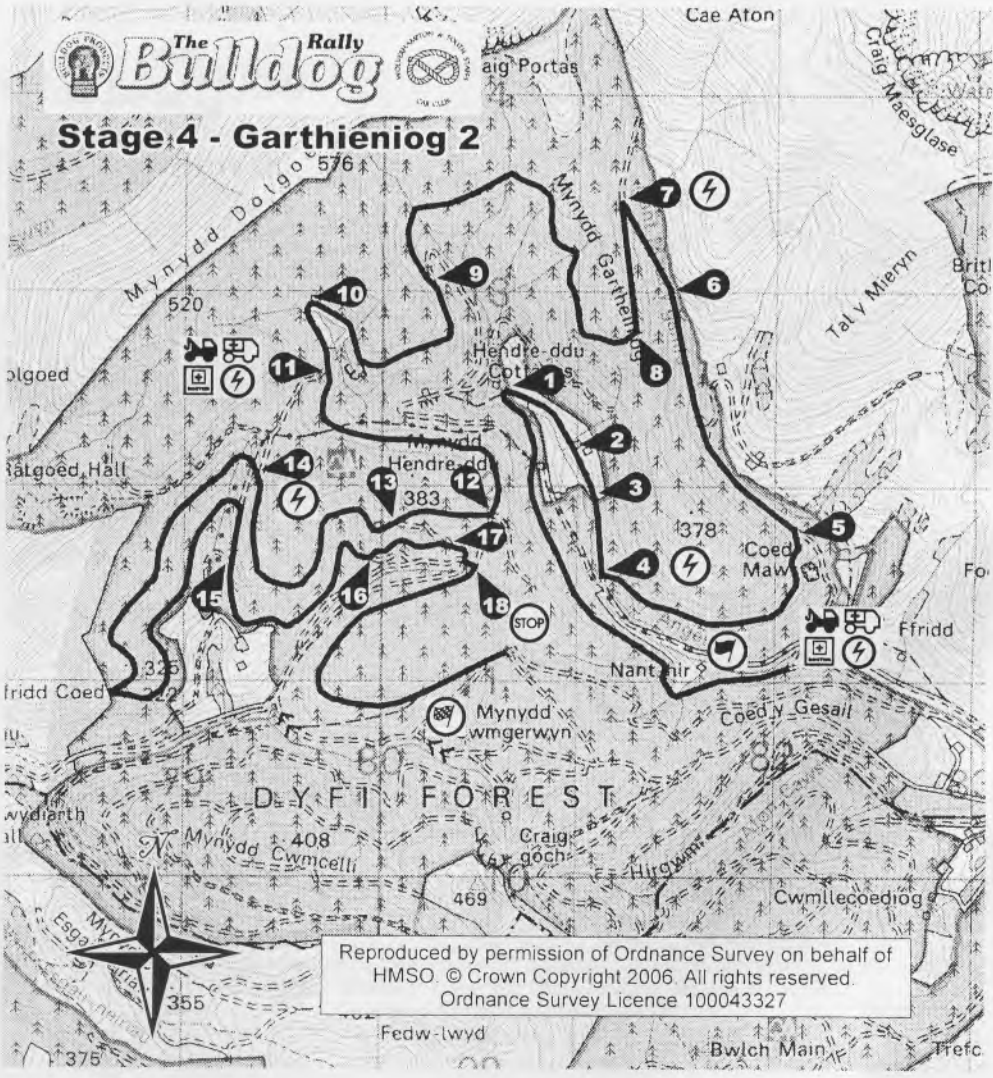
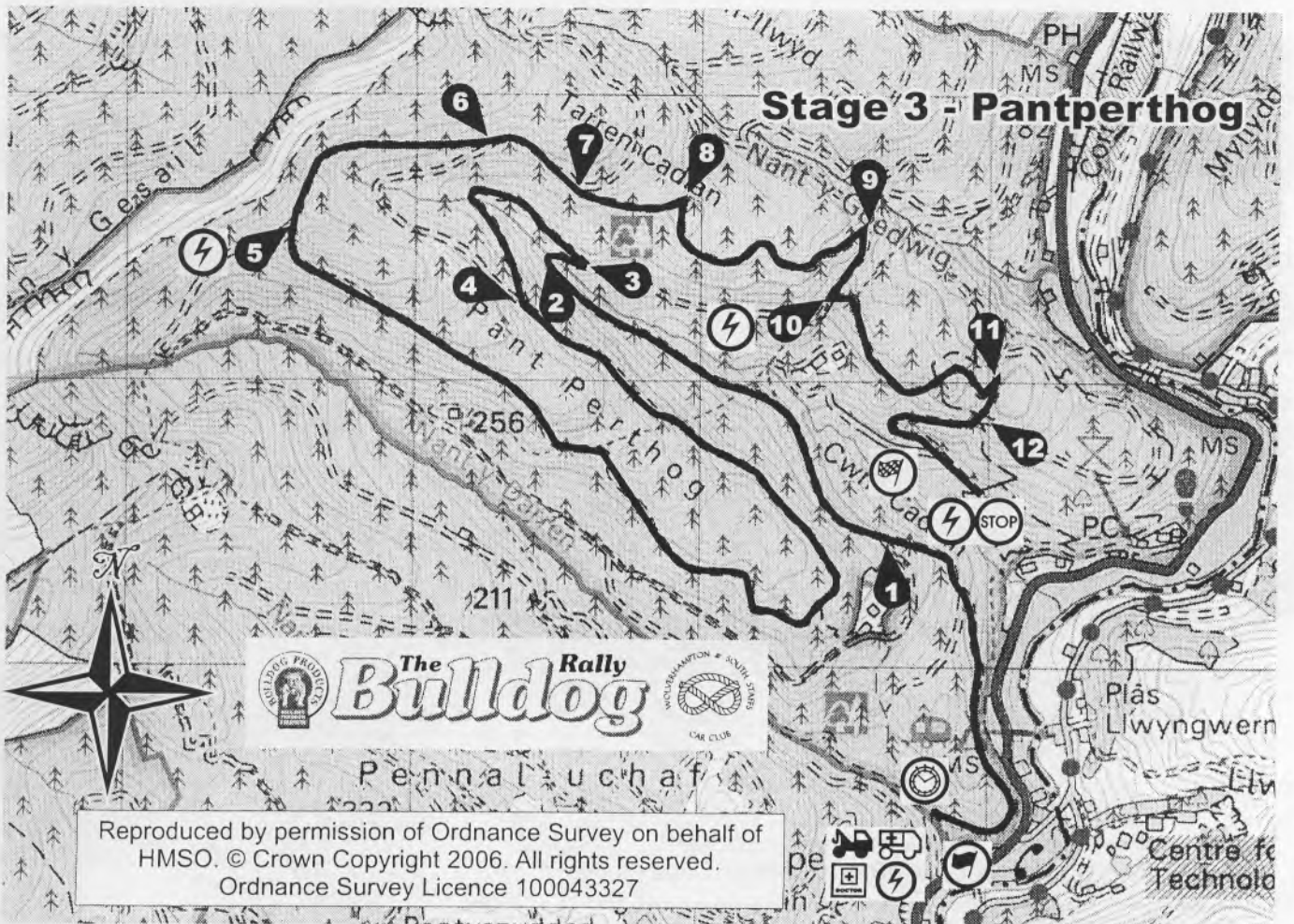

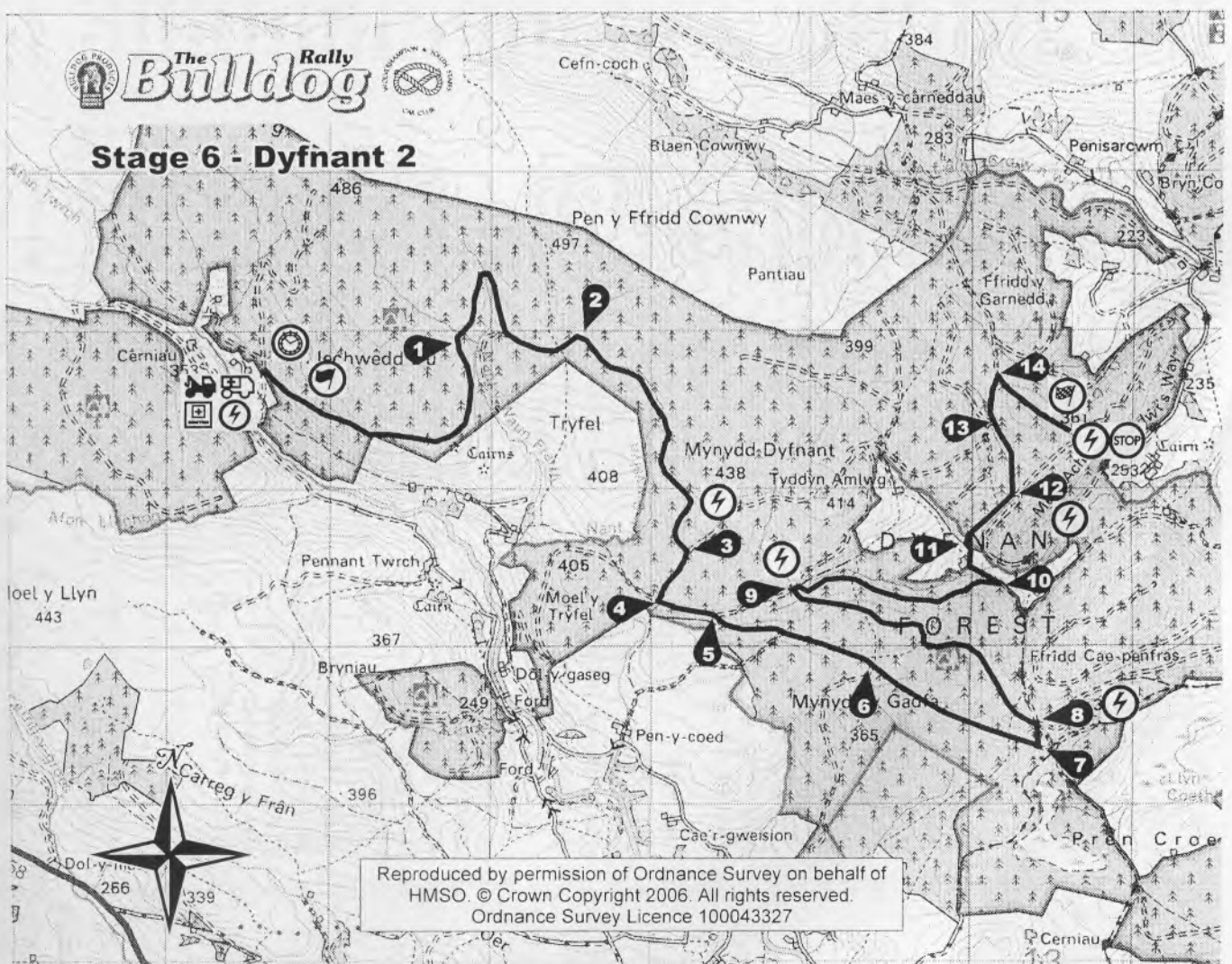
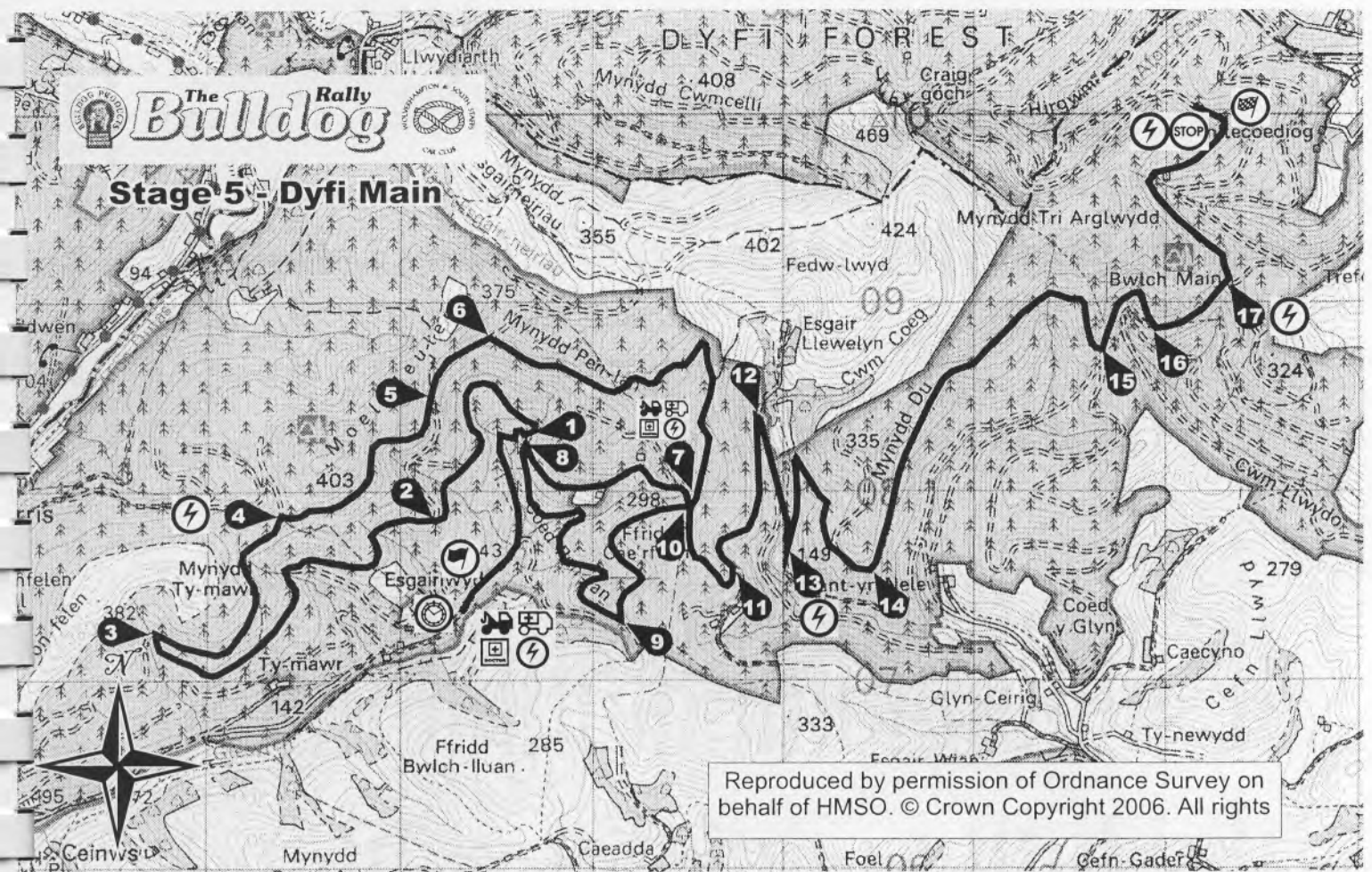

The Bulldog Rally - 21/10/2006

Entry List @ 09/10/2006

No	Entrant / Sponsor	Driver	Hometown	Co-Driver	Car	Colour	cc	Class	C-ship
63	Forward Properties	Owain Beman	Hereford	Nathan Parry	Subaru Impreza N12	White	1998T	O5	G
64	Winner Garage Ltd	Bob Morgan	Cinderford	Adrian Williams	Subaru Impreza	Red	1994T	O5	
65	Rallyhire	Raymond Mason	Moneyreagh	Peter Martin	Mitsubishi Lancer Evo 6	White	1990T	O5	
66	Air Livery	Glyn Jarman	Bury St Edmunds	Damien Rigden	Subaru Impreza N10	Blue	1998T	O5	
67		Paul Jones	Newtown	Dai Roberts	Mitsubishi Lancer Evo 7	White	1998T	O5	g
68	TAL Motorsport, Morris Lubrications	Daniel Humphreys	Oswestry	Ian Pryce	Mitsubishi Lancer	White	2000T	O5	
69	Thomas Panels & Profiles	Paul Walker	Bromyard	Vern Brown	Ford Escort Cosworth	Blue	1997T	O5	EGLegl
70	Innovation Motorsports	George Thomas	Sunderland	Graham Hopewell	Ford Fiesta ST	Red	2000	O6	FHh
71	Furrow, NEH	Chris Moore	Pencader	Richard Edwards	Ford Fiesta	Red	1998	O6	FHh
72	MAC Tyres (IRL) Ltd, O'Flynn	Kevin Davies	Deganwy	Shaun O'Gorman	Ford Fiesta	White	1998	O6	Hh
73	Stobart, VK	Simon Hughes	Ballincollig	Claire Mole	Ford Fiesta	White	1998	O6	H
74	Weaver Motorsport	Owen Murphy	Ellon	Paul Williams	Ford Fiesta ST150	White	1997	O6	Hh
75	Evans Windows, Rally Marketing	Barry Clark	Ludlow	Scott Martin	Ford Fiesta	White	1999	O6	Ff
76	Border Cleaning Machines	Neil Weaver	Llanidloes	Nick Thornton	Opel Manta	Green	1998	O3	Gg
77	G & B Finch Ltd	Geraint Mills	Oswestry	Jonny Evans	Subaru Impreza	Red	2000T	O5	Gg
78	PVC Fabrications, Alvington Car Sales	Dennis Parry	Bewdley	Mathew Parry	Ford Escort RS	White	1998	O3	
79	Adams Motor Repairs, Truck Care	Alistair Adams	Chelmsford	Andy Ballantyne	Ford Escort Mk II	Green / Silver	1998	O3	Ff
80	Jaimison's of Carryduff	Steven Finch	Camarthen	Stanley Graham	Ford Escort	Red	1998	H6	
81	AB Motorsport	Terry Brown	Oswestry	Paul Willetts	Volkswagen Golf	White / Blue	2000	O3	
82	Hormann	Anthony Hutchings	Brentwood	Kevin Hutchings	Ford Escort RS1800	White	2000	H6	lm
83	Tan Y Clawdd Garage	Keith Cornell	Papplewick	Brynmor Pierce	Ford Fiesta ST	Red	1998	O6	FHh
84	Jay & Davies Crane Hire	Tom Walster	Belfast	Kirsty Riddick	Ford Fiesta ST	White	2000	O6	
85	Cambrian Garages.	Jonathan Greer	Gretna	Killian Duffy	Ford Fiesta ST	White	1998	O6	
86		Mike Faulkner	Ayr	Peter Foy	Ford Fiesta ST	White	2000	O6	F
87		Fraser Jones	Thornbury, Nr Bristol	Inbal Edry	Ford Fiesta ST	Blue / Red	2000	O6	H
88		Adam Gould	Wrexham	Simon Sparey	Ford Fiesta ST	White	2000	O6	H
89		Paul Edwards	Llanbydder	Ian Parry	Ford Escort	Blue	2030	O4	LI
90		Grant Rees	Hereford	Wyn Davies	Nissan Sunny	Red	1998	O3	
91		Russell Davies	Nefyn	John Fellowes	Vauxhall Astra RWD	Red	2000	O3	
92		Andrew Hockridge	Haverhill	Phill Harrison	Subaru Impreza WRX	Blue	1998T	O5	
93		Brian McGuinness	Llanrwst	Ian Harden	Vauxhall Nova	Red / Silver	1400	O1	FKik
94		Arwel Jones	Llansannan	Iwan Williams	Ford Escort	Red	1998	H6	Mm
95		Jason Nash	Corwen	Peter Nash	Ford Escort	Yellow / Blue	1998	O3	GLgl
96		David Lloyd-Roberts	Saffron Walden	Dei Jones	Ford Escort	White	1998	H6	Mm
97		Richard Parry-Jones	Norfolk	Hugh Parry-Jones	Ford Fiesta ST	Blue	2000	O3	
98		Richard Archer	Foffar	Tim Rodgers	Ford Fiesta ST150	White	1998	O6	Hh
99		Richard Moore	Cramlington	Suzanne Emiliani	Ford Fiesta Trophy	White	1999	O6	FHh
100	Activmobile, Fone Logistics	Ian Gillespie	Hull	Mark Mason	Ford Fiesta ST	Blue	1994	O6	Hh
101		Chris Peart	Great Heck	Gordon Blyth	Proton Satria Kit Car	Yellow / Blue	1598	O2	Ff
102		Colin Hope	Stockton Heath	Nick Patrick	Vauxhall Nova	White	1298	O1	FKik
103	Spencer Wilkinson Construction	Spencer Wilkinson	Bala	Jamie Edwards	Subaru Impreza WRX	White	1998T	O5	EGLegl
104	J T Thorns & Co Builders, Polyroof	Tudor Morris	Kilgetty	Emyr Hall	Ford Escort	White	1998	O3	I
105		Layton Waters	Carmarthen	Robert Shaw	Toyota Starlet	Green	1998	O3	G
106		Mike Roberts		Rhydian George	Peugeot 205 GTi	Yellow	1905	O3	G

The Bulldog Rally - 21/10/2006

No	Entrant / Sponsor	Driver	Hometown	Co-Driver	Car	Colour	cc	Class	C'ship
107	D. Pritchard Builders & Developers	Paul Pritchard	Oswestry	Huw Lewis	Ford Escort Mk I	Blue	1598	O2	
108	Severn Fast Fit	Martyn Lewis	Newtown	Richard Lewis	Vauxhall Nova	White	1400	O1	Gg
109		Paul Price	Wolverhampton	Steve Link	Peugeot 106 GTi	Blue	1598	O2	Nh
110		Liam Regan	Belfast	Mark Ammonds	Ford Fiesta	Red	2000	O3	h
111		Tim Sunderland	Southampton	Kathy Barton	Ford Fiesta ST	Red	2000	O3	
112		James Everard	Hull	David Jobling	Ford Fiesta	Orange	1999	O6	
113		Alistair Weaver	London	tba	Ford Fiesta ST	White / Blue	2000	O6	
114		Chris Wilson	Church Stretton	Corin Redman	Vauxhall Astra GTE 16v	Yellow	1998	O3	
115	1st Rally Sport, C.A.R.S., Aberystwyth	Amanda Macczak	Aberystwyth	David Jones	Ford Escort Cosworth	White	1993T	O5	
116	Andy's Service Station, Billy Allen Autos	Winston Clarke	Twickenham	Rob Allen	Ford Escort RS2000	Orange	1998	O3	Ff
117	Glenroyd Developments	Gary Wright	Burscough, Lancs	tba	Peugeot 106	Red	1400	O1	L
118		Ian Sutton	Cwmbran	Heather Watkins	Hyundai Coupe	White	1998	O3	Gg
119	Jeff Thomas PlantHire, Dai Bowen	Micah Morris	Neath	Simon Anthony	Peugeot 309 SRI	White	1580	O2	Gg
120	MMS Recovery Ltd	David Williamson	Penkridge	Mark Freeman	Peugeot 205 GTi	Green	1598	O2	Nh
121	Rescue Medical Motorsport	Wayne Bonser	Abergavenny	Richard Aston	Ford Escort RS2000	Red	1993	O3	Gg
122	07710 298646 Bernard	Mike Winfield	Newport Pagnell	Andy McGowan	Peugeot 206	Red	1400	O1	FJKfjk
123	MGL Electrical	Martin Lavery	Magherafelt	Andrew Roughead	Peugeot 206	Red	1400	O1	FJKfjk
124		Alun Roberts	Machynlleth	Richard Yeomans	Nissan Micra Kit Car	Silver	1400	O1	G
125	Sureparts Motor Factors	Steve Ball	Bromsgrove	Ian Powell	Ford Escort Mk 1	White / Blue	1275	O1	Gg
126		Gwilym Roberts	Dolgellau	Gwawr Hughes	Ford Cortina Lotus Mk I	Blue	1558	H4	LMIlm
127	6th Sense Motorsport	Simon Clark	Moreton in Marsh	Ian Cozier	Vauxhall Astra	Red / White	2000	O3	
128		Ian Dean	Telford	tba	Vauxhall Astra GTE 16v	Yellow	1998	O3	
129		Julius Deane	Safron Walden	Charlie Chatburn	Peugeot 205 GTi	Red	1598	O2	
130	Thames Valley Motorsport	Nicola Parker	Reading	Mike Bennett	Peugeot 205	White	1600	O2	
131	Ridgeway Catering	Riaz Rahman	Abingdon	Simon Tappin	Peugeot 205 GTi	Blue	1600	O2	
151	Mark Harris, The Studio Leasing UK	Dave Rennocks	Cannock	Ade Camp	Vauxhall Nova	White	1600		
152	John Jarrett Racing	Owen Cule	Rothwell	Emily Goodhand	Citroen AX Sport	White	1360		
153		Jamie Davidson	Banbury	Peter Davidson	Peugeot 205 GTi	Black	1598		
154		Kevin Charles	Workington	Mark Stuart	Nissan Micra	White	998		
155		Nick Nieroda	Conwy	Denise Nieroda	Austin Mini	Black	1275		
156	Nieroda Motosport	Daniel Nieroda	Conwy	Andrew Murphy	Vauxhall Nova	White	1400		
157	Hauk - Fun for Kids	Simon Rogers	Wrexham	Tristan Rogers	Peugeot 106	Black	954		
158		Anneka Cowell	Ludlow	Ben Innes	Peugeot 205	Black	954		

Mini

Key

Aa	Driver, Co-Driver MSA Gravel Rally Championship
Bb	Driver, Co-Driver Mitsubishi Ralliart Evolution Cup
Cc	Driver, Co-Driver Subaru Group N Trophy
Dd	Driver, Co-Driver Peugeot 206 Super Cup
Ee	Driver, Co-Driver OSG & Dutton Tyres Welsh National Forest Rally Championship
Ff	Driver, Co-Driver ANCRO Clubmans Rally Championship
Gg	Driver, Co-Driver Millers Oils Welsh Clubmans Rally Championship
Hh	Driver, Co-Driver Fiesta ST Sporting Trophy
Jj	Driver, Co-Driver Peugeot 1400 Championship
Kk	Driver, Co-Driver EuroRally Cup
Ll	Driver, Co-Driver ANWCC Forest Stage Rally Championship
Mm	Driver, Co-Driver ANWCC Historic Stage Rally Championship
Nn	Driver, Co-Driver WSSCC Club Award